

ASSEMBLY INSTRUCTIONS

HANGER FOR VERTICAL LINES

VALID FOR:

Cod. K16SV (800, 1000, 1250, 1600 A)

Cod. K25SV (2000, 2500, 3200 A)

Cod. K50SV (4000, 5000 A)

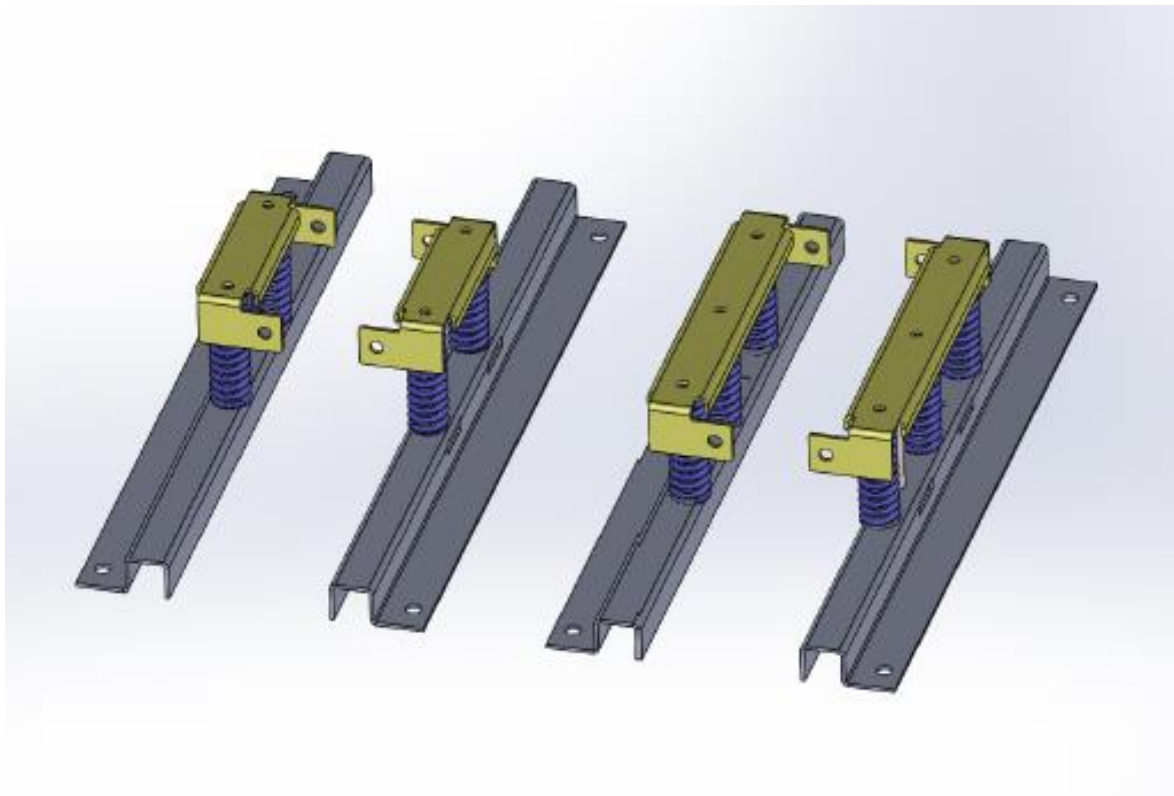

GRAZIADIO & C.^{S.P.A.}

ELETTROCONDOTTI
prefabbricati

Via Pellice 75 – 10098 – Rivoli - Italy – Tel. +39.011.9591991

Web site : www.graziadio.it – E-mail: info@graziadio.it

It is necessary to put a hanger every 8 meters of busbar in vertical and to fix on floor level starting from the bottom.

First hanger must be fixed after the first-floor crossing.

Second hanger and the following must be placed after at least 8 meters at the next available upper floor.

Decided where to place the hangers, it is necessary to set the springs preload:





1. Measure which is the distance between the one hanger and another;
2. Chose the K SERIES rating;
3. In the rating column find the distance between hangers (if it is not listed choose the upper value)
4. Read the spring preload length in mm.





Spring preload length [mm]	No. of meters between hangers (*)			
	800 - 1600 A	2000 A	2500 A & 4000 A	3200 A & 5000 A
90	21,7	15,8	12,4	11,2
91	20,9	15,2	11,9	10,8
92	20,1	14,6	11,4	10,3
93	19,1	13,9	10,9	9,9
94	18,3	13,3	10,4	9,4
95	17,5	12,7	9,9	9,0
96	16,5	12,0	9,5	8,5
97	15,7	11,4	9,0	8,1
98	14,9	10,8	8,5	7,6
99	13,9	10,1	8,0	7,2
100	13,1	9,5	7,5	6,7
101	12,2	8,9	7,0	6,3
102	11,3	8,2	6,5	5,8
103	10,5	7,6	6,0	5,4
104	9,6	7,0	5,5	4,9
105	8,7	6,3	5,0	4,5
106	7,8	5,7	4,5	4,0
107	7,0	5,1	4,0	3,6
108	6,1	4,4	3,5	3,1
109	5,2	3,8		
110	4,4	3,2		

Example:

1. For 3200 A K SERIES see the column 3200 A & 5000 A;
2. Distance between the first and second hanger is 4,3 m so find in the 3200 A column a value next to 4,3. In this case 4,3 is between 4,0 and 4,5 so please choose the upper value;
3. The upper value is 4,5 so in the same row see the Spring preload length column on the left, the value is 105 mm. This is the spring preload to apply.

(*) For the last hanger consider the distance between it and the end of the line (or the next elbow).

1	<p>Unpack the hangers. You will find two pieces.</p> 	2	<p>Remove first the four M10x25 screws.</p> 
3	<p>Screws removed.</p> 	4	<p>Set the springs to the length indicated in the above table to preload the springs to the right weight.</p> 
5	<p>Place the hangers on the floor and find the final position of the busbar.</p> 		

6	<p>Approach the two hangers. The hangers shall be perfectly in contact with the busbar.</p> 	7	<p>Drill the side of the busbar with a 11mm drill bit. Repeat the same procedure for both sides.</p> 
8	<p>The result should be like this.</p> 		
9	<p>Insert and fasten the four M10x25 screws, with a torque wrench, to 50Nm.</p> 	10	<p>The result should be like this.</p> 

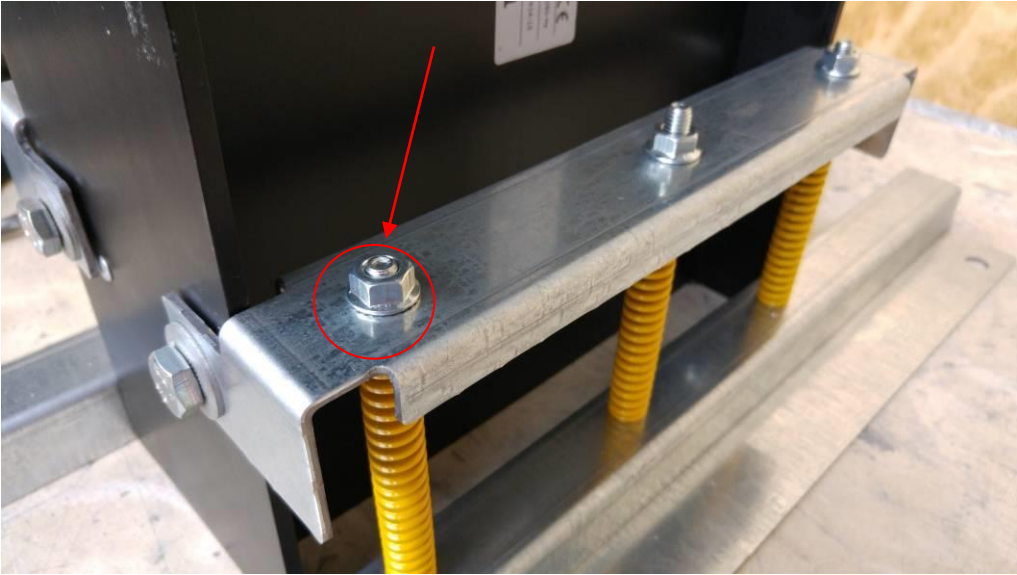
11	<p>Fix the hanger to the floor.</p> 	12	<p>Fix in the same way the others vertical hangers.</p>
13	<p>When all the hangers will be installed, unscrew all the nuts so the vertical line will be fully suspended by the spring and free to move.</p> 		

FOR FURTHER INFORMATION: tel. +39.011.9591991 e-mail: info@graziadio.it